



Terminal Box Ex d

8252/1



Contents

1	General Information	2
1.1	Manufacturer	2
1.2	Information regarding the operating instructions	2
1.3	Conformity with standards and regulations	2
2	Symbols Used	3
3	General Safety Notes	3
4	Intended Use	3
5	Special Versions	4
6	Technical data	4
7	Transport and storage	5
8	Installation	5
8.1	Dimensions / fastening dimensions	5
9	Assembling and Dismantling	6
10	Installation Conditions	7
11	Installation	8
11.1	Remove / Tighten the Enclosure Cover	8
11.2	Protective Conductor Connection	8
11.3	Internal wiring	9
11.4	Electrical Connection	9
11.5	Cabling	10
11.6	Installation and Retrofitting of Terminals	10
12	Putting into Service	11
13	Maintenance, overhaul and repair	11
14	Accessories and Spare Parts	12
15	Disposal	12

1 General Information

1.1 Manufacturer

R. STAHL Schaltgeräte GmbH
Am Bahnhof 30
74638 Waldenburg
Germany

Tel.: +49 7942 943-0
Fax: +49 7942 943-4333
Internet: www.stahl-ex.com
E-Mail: info@stahl.de



1.2 Information regarding the operating instructions

ID-No.: 213859 / 825260300060
Publication Code: 2015-03-25-BA00-III-en-04
Subject to alterations.



1.3 Conformity with standards and regulations

Conformity with standards and regulations is specified in the corresponding certificates and the EC Declaration of Conformity. These documents can be downloaded from our homepage www.stahl-ex.com.

2 Symbols Used

	<p>Safety Instructions Non-observance may cause damage to the equipment, serious injuries or even death. The safety instructions in this operating instructions and on the device must be observed!</p>
	<p>Warning Symbol Danger due to explosive atmosphere!</p>
	<p>Warning Symbol Danger due to live parts!</p>

3 General Safety Notes

 WARNING	
<p>Use the devices only for the permitted purpose! Incorrect or unauthorized use or non-compliance with these instructions invalidates our warranty provision. Alterations and modifications to the device which impair its explosion protection are not permitted. Use the device only if it is undamaged.</p>	
 WARNING	
<p>Installation work must be carried out by qualified personnel! Installation, maintenance, overhaul and repair may only be carried out by appropriately authorized and trained personnel.</p>	

Observe the following information during installation and operation:

- Any damage can invalidate the explosion protection
- National and local safety regulations
- National and local accident prevention regulations
- National and local assembly and installation regulations
- Generally recognized technical regulations
- Safety instructions in these operating instructions
- Characteristic values and rated operating conditions on the rating and data plates
- Additional instruction plates fixed directly to the device

4 Intended Use

The terminal boxes of Series 8252/1 of types of protection flameproof encapsulation "d" and protected by the enclosure "tb" are explosion-protected equipment, approved for use in Zones 1, 2 und 21, 22. They are used for distributing electrical energy in hazardous areas.

5 Special Versions

Special version

In case of additional/different order options, special versions may differ from the description given here.

6 Technical data

Technical Data

Explosion protection

Global (IECEX)	
Gas and dust	IECEX BVS 11.0059X Ex d [ia/ib Ga/Gb] IIC T4-T6 Gb Ex tb IIIC T80°C-T130°C Db IP66
Europe (ATEX)	
Gas and dust	BVS 11 ATEX E 114 X ⊕ Ex II 2 G Ex d [ia/ib Ga/Gb] IIC T4-T6 Gb ⊕ Ex II 2 D Ex tb IIIC T80°C-T130°C Db IP66
Certifications and certificates	IECEX, ATEX, India (PESO), Kazakhstan (TR), Russia (TR), Belarus (TR)
Ambient temperature	-60 ... +70 °C depending on explosion-protected built-in components used
Rated operational voltage	max. 690 V depending on explosion-protected built-in components used
Rated operational current	max. 175 A depending on explosion-protected built-in components used
Connection cross-section	max. 70 mm ² depending on explosion-protected built-in components used

Material

Enclosure	aluminium cast alloy copper-free, powder-coated to RAL 7032
Seal	silicone O-ring

Protective conductor connection

	M6 earth bolt, inside/outside on the enclosure
Tightening torque	screw of the protective conductor connection: 2.8 Nm
Degree of protection	IP66 acc. to IEC/EN 60529
Assembly	2 mounting holes
Note	Max. thread sizes per enclosure side, see chapter "Dimensions / Mounting Dimensions".

NOTICE

Powder coated enclosures must not be used in areas where intense electrostatic charging may occur.

7 Transport and storage

- Transport and storage are permitted only in the original packaging.
- The devices must be stored in a dry place and vibration-free.

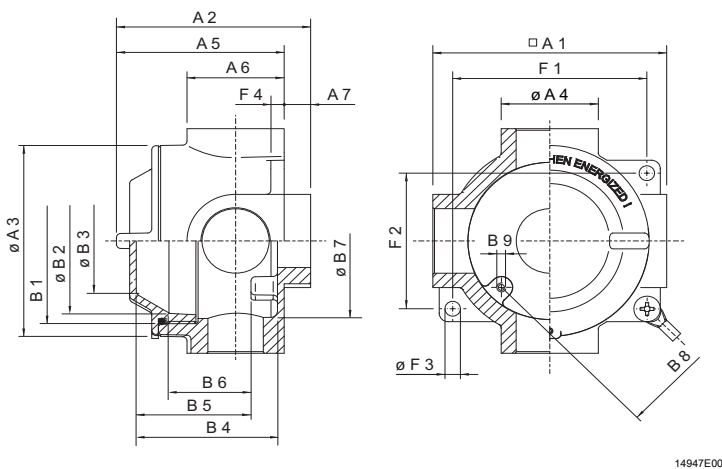
8 Installation**8.1 Dimensions / fastening dimensions**

	Enclosure (dimensions in mm)			
	Size 1	Size 2	Size 3	Size 4
	8252/11-...-..	8252/12-...-..	8252/13-...-..	8252/14-...-..
□A1	72	106	120	156
A2	74	88	110	126
ØA3	65	90	110	145
ØA4	36	44	54	75
A5	64	76	99	115
A6	36	44	54	75
A7	12	12	12	12
B1	M54	M80	M95	M130
ØB2	46	72	85	123
ØB3	20	52	67	99
B4	56	64	83	98
B5	41	52	71	86
B6	44	36	57	66
ØB7	48	73	87	123
B8	36	61	77	111
B9	M4	M4	M4	M4
F1	60	88	102	136
F2	56	64	78	96
ØF3	7	7	7	7
F4	6	6	6	3
Max. Gewindegröße				
Metrisch	M25	M32	M40	M63
NPT	3/4"	1"	1-1/4"	2"

9 Assembling and Dismantling

Mounting

NOTICE

If the explosion protected equipment is exposed to the weather, it is advisable to provide a protective cover or wall.

- Fasten the enclosure using two screws (see chapter "Dimensions / Mounting Dimensions").
- Tighten the screws.

10 Installation Conditions

Clearance and creepage distances

- When installing components the clearance and creepage distances between the individual components and between the components and the enclosure walls must be sufficiently dimensioned.
- The creepage distances between the components must be tested and observed according to the guidelines of the relevant operating instructions. The clearance distances, depending on the rated operational voltage of the fitted terminals, must be complied with.
- On all terminal boxes, the distance between enclosure cover and connection screws of the built-in components (with the conductor connected) has to be observed: it must at least have the value of the required creepage distances, for example (14 mm at 1100 V.

Distance between connection parts for intrinsically safe and non-intrinsically safe circuits

- Partitions used to separate connection terminals shall extend to within 1.5 mm of the enclosure walls, or alternatively shall provide a minimum distance of 50 mm between the bare conducting parts of the connection terminals when measured in any direction around the partition.
- The minimum thickness of metal partitions must be 0.45 mm. They must be earthed and have sufficient strength and stiffness to ensure that they will not be damaged during connection work. Furthermore, the metal partitions must be equipped with sufficient current-carrying capacity in order to prevent a burn out or disconnection of the earth connection under fault conditions.
- The minimum thickness of nonmetallic, insulating partitions must be 0.9 mm. They must have an appropriate comparative tracking index (CTI) and must be reinforced in such a way that no deformation can occur.
- When fuses > 4 A are used, care must be taken to ensure that no inadmissible heating at the terminals of intrinsically safe circuits can occur.

Covers for combinations of non-intrinsically safe and intrinsically safe circuits

- All live parts which do not conform to the "Ex i" degree of protection must be equipped with an inner cover which meets at least the ingress protection rating IP30 when the equipment is opened.

Intrinsically safe circuits

- In intrinsically safe circuits only insulated cables and conductors with a test voltage of at least 500 V AC and a minimum quality of H05 are permitted.
- With regard to the insulation and separation of terminals and cables, it has to be observed that the insulation test voltage is derived from the sum of the rated operational voltages of intrinsically safe and non-intrinsically safe circuits.
- The diameter of single conductors/ finely stranded single conductors must not be smaller than 0.1 mm.



In the case of "intrinsically safe to earth", the minimum insulation voltage is 500 V (otherwise double the rated operational voltage of intrinsically safe circuits). In the case of "intrinsically safe to non-intrinsically safe", the minimum insulation voltage is 1500 V (otherwise double the rated operational voltage plus 1000 V).

Clearance and creepage distances of intrinsically safe components

The clearance and creepage distances between the blank, conductive parts of connection terminals of separated, intrinsically safe circuits to earthed or potential-free, conductive parts must be equal or greater than the values of IEC/EN 60079-11, Table 5. If separated, intrinsically safe circuits have to be considered, the safety distance between the blank, conductive parts of the outer connections must be as follows:

- minimum 6 mm between the separated, intrinsically safe circuits
- minimum 3 mm to the earthed parts, if a possible connection to earth has not been considered in the safety analysis

11 Installation

 WARNING	
	<p>If components are damaged or installed incorrectly, explosion protection is no longer guaranteed!</p> <ul style="list-style-type: none"> ▶ Use the device only if it is undamaged. ▶ If the thread is damaged, the device must be replaced immediately. ▶ The permitted ambient temperature at the built-in intrinsically safe devices and components must not be exceeded.

11.1 Remove / Tighten the Enclosure Cover

Enclosure cover



Unscrewing the enclosure cover

- Carefully unscrew the enclosure cover and put it aside.

Screwing down the enclosure cover

- To prevent corrosion, the cover thread must be coated with acid-free grease (OKS seawater-resistant art. no. 105082, see chapter "Accessories and Spare Parts").
- Screw enclosure cover carefully onto lower enclosure part (do not tilt the thread).
- Screw in thread all the way.

11.2 Protective Conductor Connection

 WARNING	
	<p>Always connect the protective conductor!</p> <p>The device is equipped with an internal and external protective conductor connection.</p>

- Regardless of the operating voltage, connect all uncoated non-energized metal parts to the protective conductor system.
- For information on potential equalization (PA), potential earth (PE) and intrinsically safe circuits, please refer to the documentation of the associated equipment.

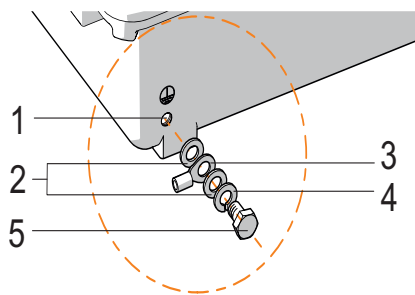

- 1 = Thread (M6) in the enclosure
 2 = Washer
 3 = Protective conductor with cable lug
 4 = Screw locking
 5 = Screw (M6)

06817E00

Connecting the protective conductor with cable lug:

- Fasten washer (2), protective conductor with cable lug (3), screw locking (4) to the thread in the enclosure (1) with the screw (5).
- Tighten the screw (5) (tightening torque 2.8 Nm)
- Run and fix the cable near the enclosure to prevent loosening of the cable.



11.3 Internal wiring



⚠ WARNING	
	<p>If cables and lines are damaged, explosion protection is no longer guaranteed!</p> <p>▶ Run cables and lines such that they do not become bent or chafed through during operation.</p>

11.4 Electrical Connection

- Open the enclosure.
- The conductor must be carefully connected.
- Make sure that the conductor insulation reaches right up to the terminal.
- Do not damage (nick) the conductor when stripping the insulation.
- Ensure that the maximum permissible conductor temperatures are not exceeded by suitable cable selection and layout.
- Observe the data of the terminal manufacturer.
- Carefully close the enclosure after completing the work.

11.5 Cabling

 WARNING	
	<p>When using cable glands that have not been approved, explosion protection is no longer guaranteed!</p> <ul style="list-style-type: none"> ▶ Only cable glands with suitable approval may be used. They must be suitable for the cable type used and must meet the requirements of IEC/EN 60079-14. ▶ To guarantee explosion protection, the cable glands must be mounted in accordance with the manufacturer's specifications. ▶ For unused enclosure holes, use Ex d stopping plugs, for unused cable glands, use Ex d plugs. Make sure that these components have appropriate approval and meet the requirements of IEC/EN 60079-14.

 WARNING	
	<p>When using connection cables that have not been approved, explosion protection is no longer guaranteed!</p> <ul style="list-style-type: none"> ▶ The connection cables must comply with the relevant regulations and must have the required cross-section. ▶ The connection cable diameters and the diameter specified on the cable gland must be identical.

NOTICE	
For the thread sizes of the cable glands, please refer to the relevant documentation.	

- Introduce the connection cables, including the complete external insulation, through the cable glands into the connection chamber.
- Make sure that the cable diameters and the clamping cross-section of the cable gland are identical.
- Run the connection cables in the connection chamber such that
- the bending radii for the respective conductor cross-section do not fall below the minimum permissible values.
- the conductor insulation is not mechanically damaged by sharp-edged or moving metal parts.

11.6 Installation and Retrofitting of Terminals



The terminal boxes of the 8252/1.. type can be retrofitted with terminals of the same type and connection cross-section. The terminal types, their current and voltage ratings as well as the maximum number of terminals are listed in Table 1. All these values are maximum values which must not be exceeded.

Table 1:

Terminal type	MBK 2.5/E	MBK 3/E-Z	MBK 5/E-Z	UT 2.5	UT 4	UT 6	UT 10	UT 16	ST 2.5	ST 4	ST 6	STTB 2.5	STTB 4
Rated voltage	176 V	275 V	500 V	690 V	690 V	690 V	690 V	690 V	550 V	550 V	550 V	440 V	550 V
Rated current	22 A	28 A	32 A	30 A	41 A	53 A	74 A	97 A	29 A	36 A	48 A	25 A	36 A
Maximum number of terminals	Enclosure size 2 8252/12	8	8	8	-	-	-	-	-	-	-	-	-
	Enclosure size 3 8252/13	10	10	8	6	5	4	-	-	6	4	-	-
	Enclosure size 4 8252/14	17	17	14	11	11	10	6	5	11	10	4	5

Versions differing from the specifications given in Table 1, such as mixed equipment with terminals of different cross-sections or types, can only be supplied ex factory. Subsequent changes or retrofitting are not possible in this case.



12 Putting into Service

 WARNING	
	No explosion protection if enclosure is improperly closed! The device must be operated only with completely closed enclosures.

Before putting into service

- Make sure that the components are not damaged.
- Make sure that the device has been installed correctly.
- Remove any foreign objects from the device.
- Check the tightening torques.

13 Maintenance, overhaul and repair

 WARNING	
	Live parts may cause electric shock! Do not open the enclosure when live!

The following details must be checked during maintenance:

- Compliance with the permitted temperatures (according to ANSI/ISA 60079)
- Damage to the enclosure and to the thread

14 Accessories and Spare Parts

⚠ WARNING	
	<p>If wrong accessories are used, explosion protection cannot be guaranteed!</p> <ul style="list-style-type: none"> ▶ Use only original R. STAHL accessories and spare parts. ▶ Make sure that only suitable components with appropriate certification are built into the enclosure.

Accessories and Spare Parts

Designation	Description	Art. no.	Weight kg
OKS special grease, seawater-resistant	for easier dismounting and as anticorrosive for the cover thread	105082	1.000

15 Disposal

The national waste disposal regulations have to be observed.

EG/EU-Konformitätserklärung
EC/EU Declaration of Conformity
Déclaration de Conformité CE/UE



R. STAHL Schaltgeräte GmbH • Am Bahnhof 30 • 74638 Waldenburg, Germany
 erklärt in alleiniger Verantwortung, declares in its sole responsibility, déclare sous sa seule responsabilité,

dass das Produkt: **Klemmenkasten**
that the product: *Terminal Box*
que le produit: *Boîte de raccordement*

Typ(en), type(s), type(s): **8252/1**

mit den Anforderungen der folgenden Richtlinien und Normen übereinstimmt.
is in conformity with the requirements of the following directives and standards.
est conforme aux exigences des directives et des normes suivantes.

Richtlinie(n) <i>Directive(s)</i> <i>Directive(s)</i>		Norm(en) <i>Standard(s)</i> <i>Norme(s)</i>
Bis/Until/Jusque 2016-04-19:	Ab/From/De 2016-04-20:	EN 60079-0:2012+A11:2013 EN 60079-1:2014 EN 60079-11:2012 EN 60079-31:2014
94/9/EG: ATEX-Richtlinie	2014/34/EU:	
<i>94/9/EC: ATEX Directive</i>	<i>2014/34/EU:</i>	
<i>94/9/CE: Directive ATEX</i>	<i>2014/34/UE:</i>	

Kennzeichnung, marking, marquage: **II 2(1) G Ex db [ia Ga] [ib] IIC T6...T4 Gb** **0158**
II 2 D Ex tb IIIC T80 °C...T130 °C Db IP66

EG/EU-Baumusterprüfbescheinigung: **BVS 11 ATEX E 114 X**
EC/EU Type Examination Certificate: *(DEKRA EXAM GmbH,*
Attestation d'examen CE/UE de type: *Dinnendahlstraße 9, 44809 Bochum, Germany, NB0158)*

Produktnormen nach Niederspannungsrichtlinie: EN 60947-1:2007+A1:2011+A2:2014
Product standards according to Low Voltage Directive: EN 60947-7-1:2009
Normes des produit pour la Directive Basse Tension: EN 60947-7-2:2009
 EN 60947-7-3:2009
 EN 61439-1:2011
 EN 62208:2011

Bis/Until/Jusque **Ab/From/De**
2016-04-19: **2016-04-20:**
2004/108/EG: EMV-Richtlinie **2014/30/EU:**
2004/108/EC: EMC Directive *2014/30/EU:*
2004/108/CE: Directive CEM *2014/30/UE:*

Nicht zutreffend nach Artikel 1, Absatz 3.
Not applicable according to article 1, paragraph 3.
Non applicable selon l'article 1, paragraphe 3.

2011/65/EU **RoHS-Richtlinie** **EN 50581:2012**
2011/65/EU *RoHS Directive*
2011/65/UE *Directive RoHS*

Waldenburg, 2016-03-29

i.V.

Ort und Datum
Place and date
Lieu et date

Holger Semrau
Leiter Entwicklung Schaltgeräte
Director R&D Switchgear
Directeur R&D Appareillage

i.V.

J.-P. Rückgauer
Leiter Qualitätsmanagement
Director Quality Management
Directeur Assurance de Qualité